

# HARDWARE - CLOSERS

## Concealed Overhead Closer

For Offset Doors with Brackets and Arm



Mounting  
Clips

C.O.C Cover Plate

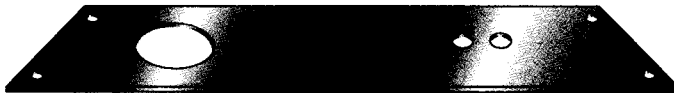

Offset Arm



Slide Channel

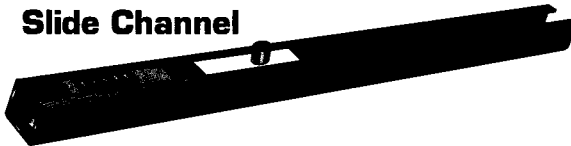

Channel Door Stop



Parallel Arm

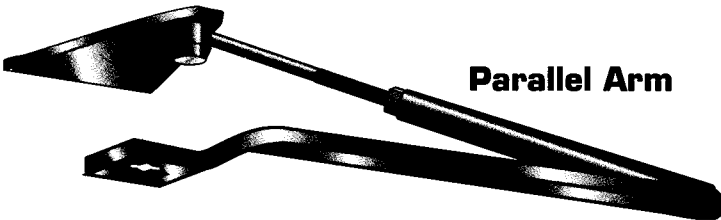

Drop Plate

For Easy Mounting of Surface Mounted Closer on Door Frame

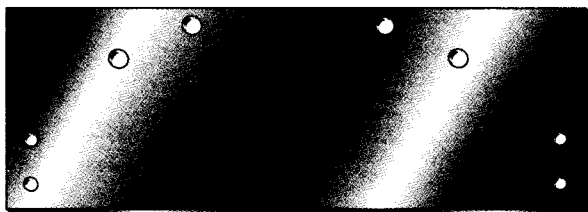

## Concealed Overhead Closer

For Center Hung Doors with Brackets and Arm



Mounting  
Clips

C.O.C Cover Plate



End Load Arm



## Surface Mounted Closer

with Regular Arm  
H.O. available upon request

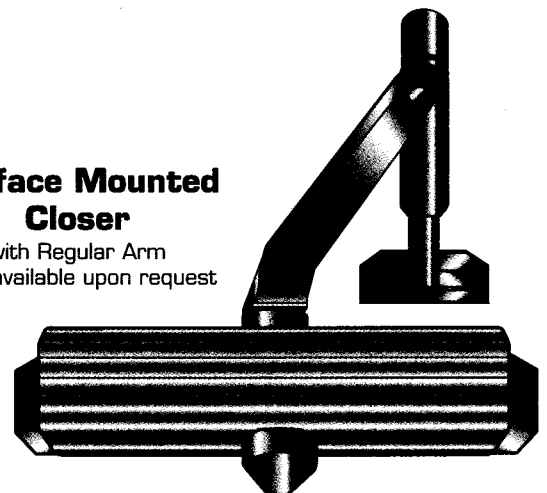

# HARDWARE - PUSH/PULLS



**64-103**  
Standard Pull Handle  
12" Long - 10-3/8" C/L



**64-102**  
Push Bar  
Assembly

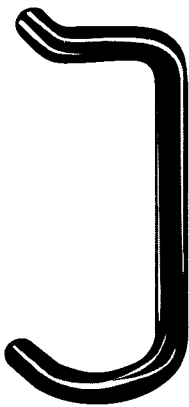

**64-108**  
Offset Wire Push/Pull



**Special Order**  
Straight Wire Pull

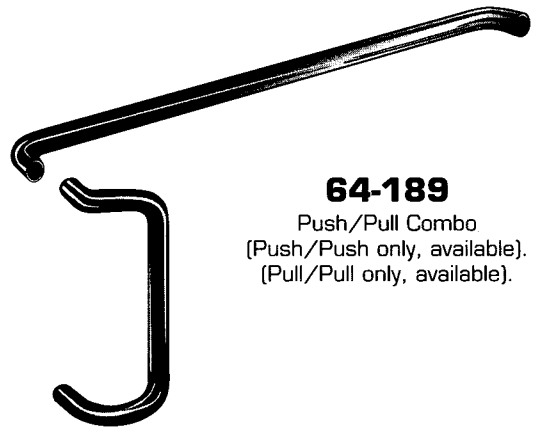

**64-189**  
Push/Pull Combo  
(Push/Push only, available).  
(Pull/Pull only, available).



**64-106**  
Hallet Pull

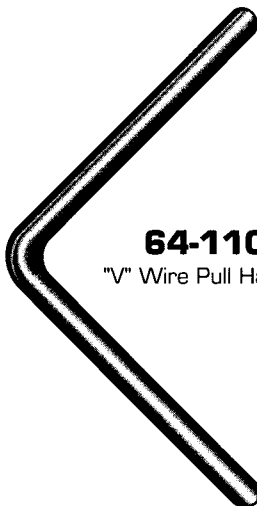

**64-110**  
"V" Wire Pull Handle



**64-126**  
Crash Bars

*Shown above is Rebco's  
standard hardware.  
Custom hardware is  
available on request.*

# HARDWARE - PUSH/PULLS



**64-103**  
Standard Pull Handle  
12" Long - 10-3/8" C/L



**64-102**  
Push Bar  
Assembly

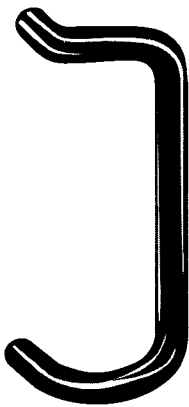

**64-108**  
Offset Wire Push/Pull



**Special Order**  
Straight Wire Pull

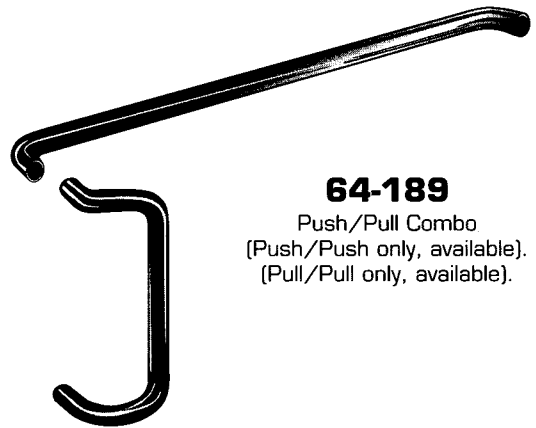

**64-189**  
Push/Pull Combo  
(Push/Push only, available).  
(Pull/Pull only, available).



**64-106**  
Hallet Pull

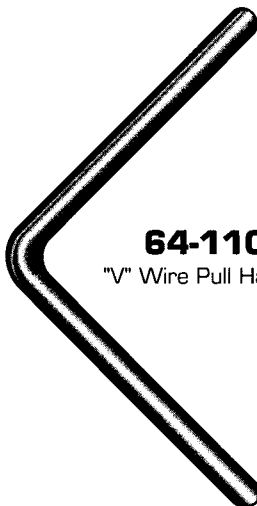

**64-110**  
"V" Wire Pull Handle



**64-126**  
Crash Bars

*Shown above is Rebco's  
standard hardware.  
Custom hardware is  
available on request.*

# HARDWARE - CYLINDERS & FLUSH BOLTS

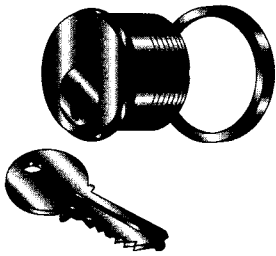

**64-321**  
REBCO Solid Brass  
Mortise Cylinder



**64-ESC**  
Escutcheon

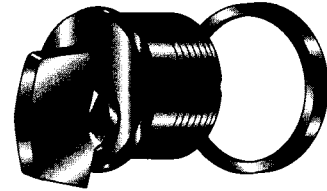

**64-323**  
Solid Brass Thumb  
Turn Cylinder

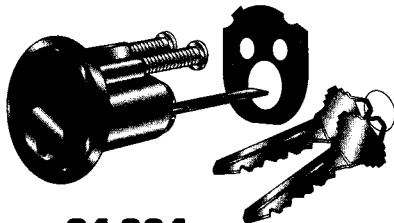

**64-324**  
Solid Brass Rim Cylinder

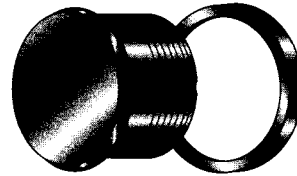

**64-325**  
Dummy Cylinder

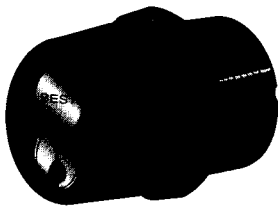

**64-BWC (With Core)**  
Best Mortise Cylinder

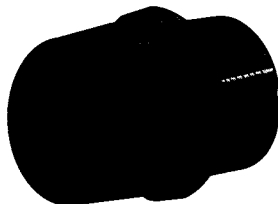

**64-BNC (No Core)**  
Best Mortise Cylinder

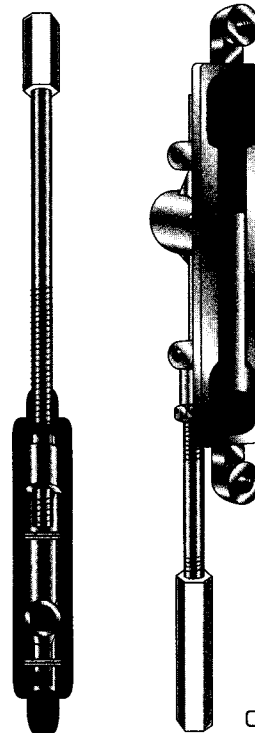

**64-330**  
Complete Flush Bolts

# 5" WIDE STILE DOOR



41-002 (Adjustable)

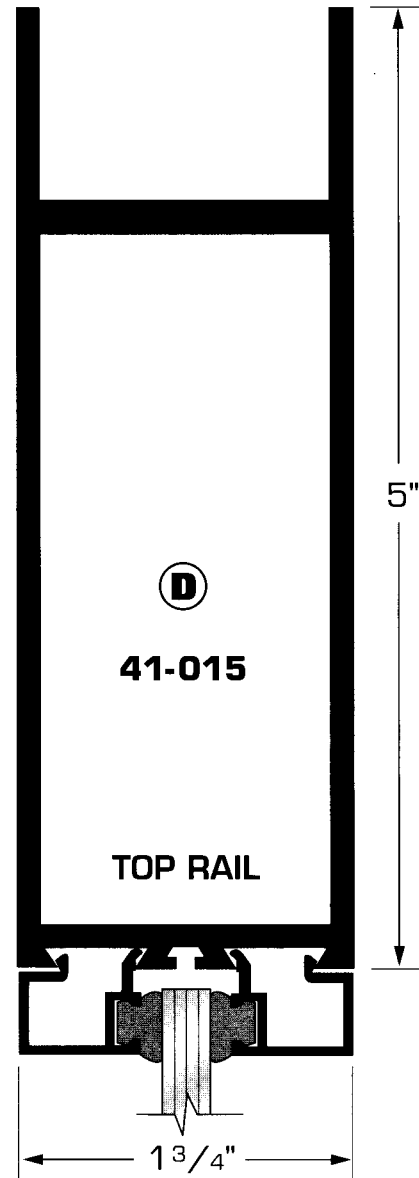
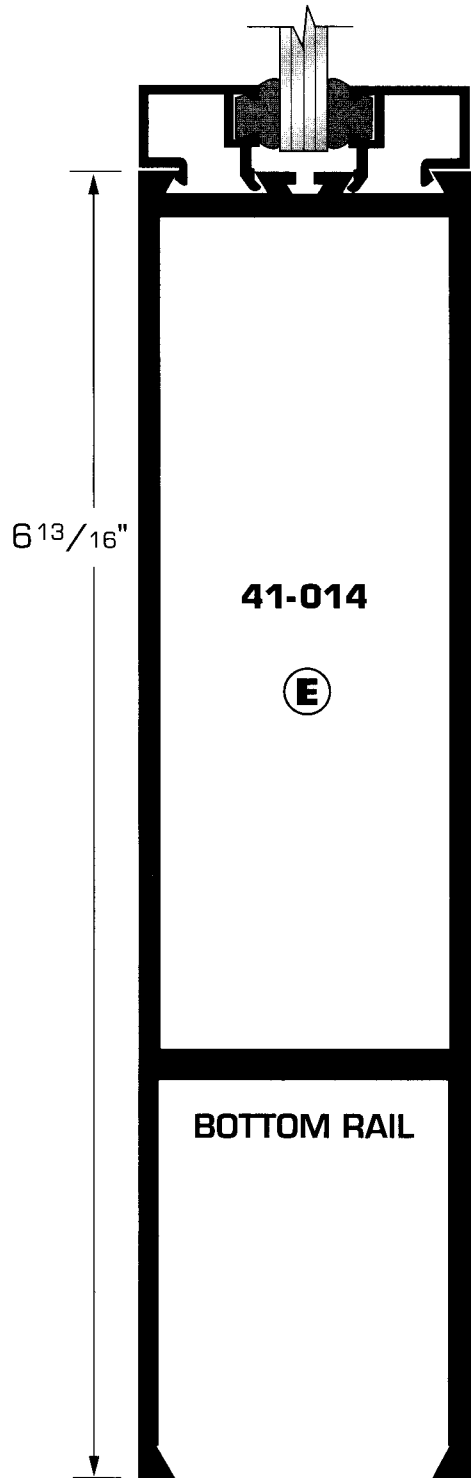

# 5" WIDE STILE DOOR



41-002 (Adjustable)

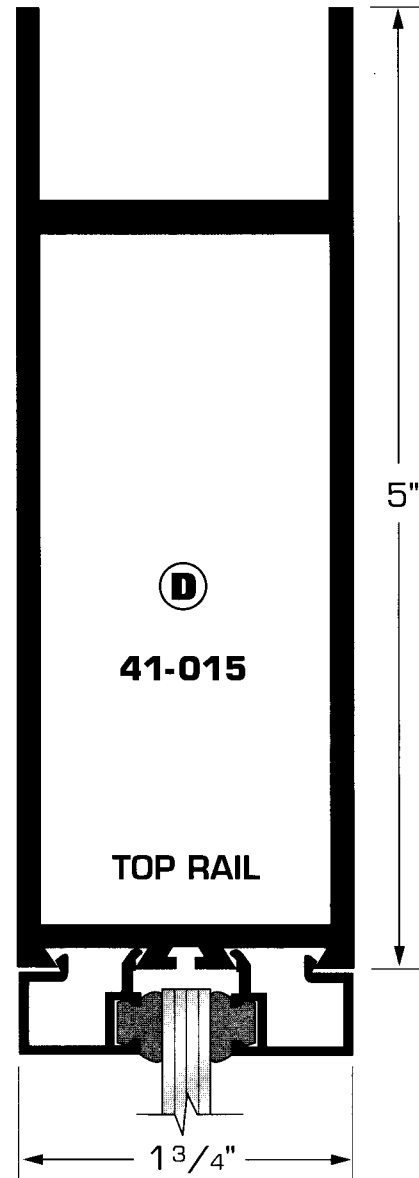
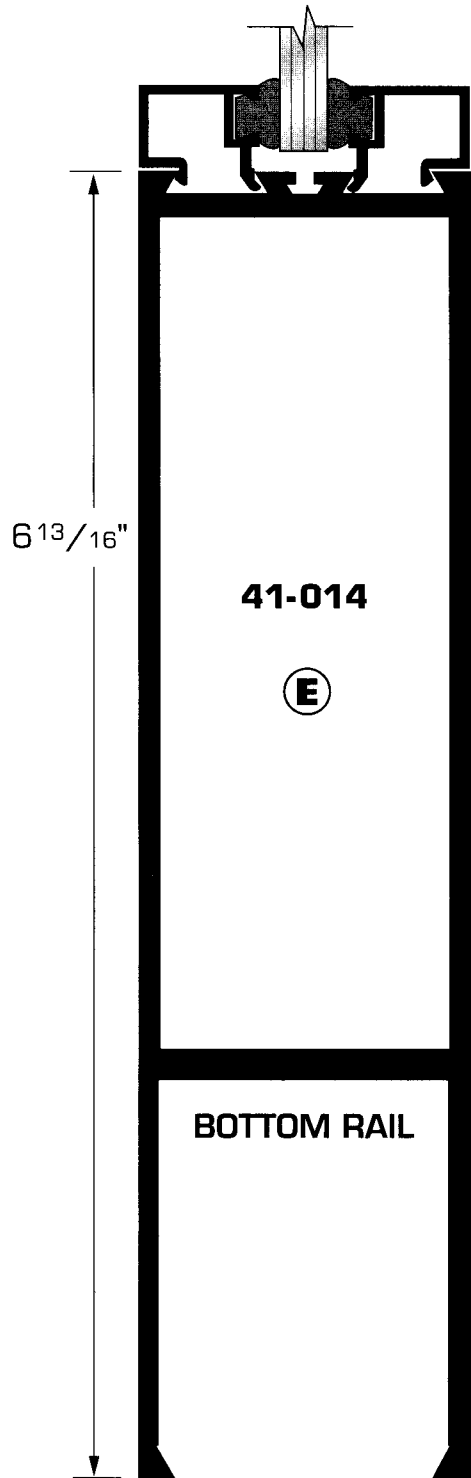

# C.O.C CONDITIONS

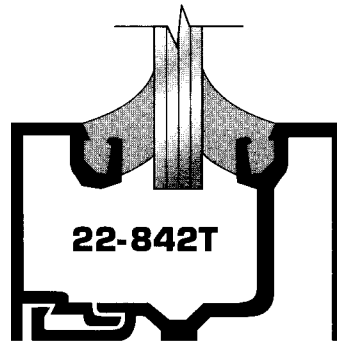

**Transom  
Condition  
for 1/4" Glazing**

**4517-OH** →

→ **CONCEALED OVERHEAD CLOSER**

**45-OHF** ↗

*Shown is a typical 1-3/4" x 4-1/2" framing detail. Other sized headers are available on request and will be used with other members.*

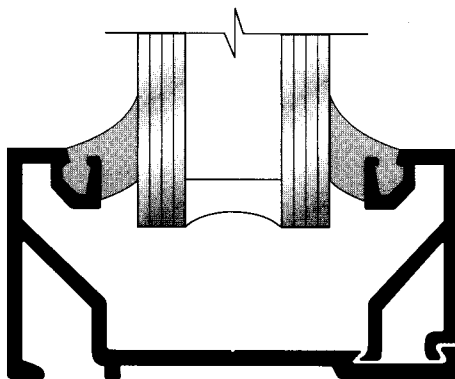

**22-620T SASH  
Transom Condition  
for 1" Glazing**

